

CMC-5100

CMD-5200

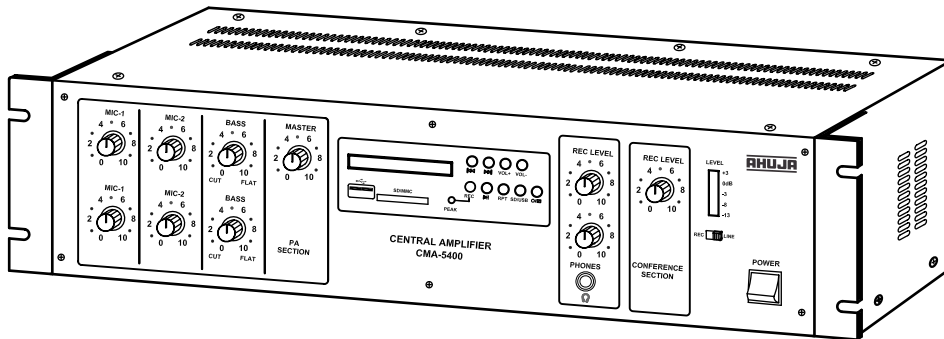

CMA-5400 Central Amplifier

- ◆ Thank you for purchasing the AHUJA Conference System.
- ◆ Please read this manual thoroughly before making connections and turning on the power. Following the instructions in this manual will enable you to obtain optimum performance from your new AHUJA Conference System.
- ◆ Please retain this manual for future reference.

• Safety Instructions

Read the Instructions: Please read all the instructions in this section carefully before installation or use of the product. All the safety instructions must be followed.

Retain the Instructions: Please retain this Instruction Manual for future reference.



This symbol, wherever it appears, alerts you to the presence of uninsulated hazardous voltage that may be sufficient to constitute a risk of electric shock. External wiring to any terminal marked with this symbol must be done by a trained and instructed person only.



This symbol, wherever it appears adjacent to a component, alerts you that the concerned component can only be replaced by another of the exact same specifications.

WARNING

- To reduce the risk of electric shock, do not remove the top cover. No user serviceable parts inside. Refer all servicing to qualified personnel only.
- Before replacing any fuse, make sure the set is switched off and disconnected from the AC mains or any other power source. Replace a fuse only with another of exactly same specification.

CAUTIONS

Water & Moisture: To reduce the risk of fire or electrical shock, do not expose this set to rain or moisture. Do not use this set near water or in a wet location. Do not keep any object filled with liquid, such as a vase, on top of this set. Do not insert or remove the AC mains plug with wet hands.

Power Source: The voltage & frequency of the AC mains supply, and the voltage of the external battery, (if applicable) to which this set can be connected, is marked on the rear panel of the set. Do not connect this set to any power source other than those specified on the rear panel.

Power Cord Protection: Do not cut, kink, damage or modify the AC power cord supplied with this set. Keep the AC power cord away from heaters and harmful chemicals. Do not keep any heavy object on the power cord.

Operation on Generator: When operating this set on a generator, make sure the set is switched off till the generator voltage has stabilized.

Ventilation: This set should be situated so that its location or position does not interfere with its proper ventilation. Do not cover the ventilation holes / slots. Do not insert or drop anything into the ventilation holes / slots.

Stability: This set must be kept in a stable and flat horizontal position, and never in a tilted position. Do not place this set on an unstable stand, tripod, bracket or mount. Do not use attachments which are not supplied or explicitly recommended by the manufacturer.

Cover Strip: The cover strip of the 100V / 70V audio output terminal strip, and of any other high voltage output terminal strip, must be replaced after making connections. Failure to do so may result in exposure to hazardous voltages.

Earthing: This set must be earthed properly before use. A wire from the Earth terminal on the rear panel must be connected to electrical earth.

Cleaning: Disconnect this equipment from the AC mains and external battery before cleaning. Clean with a damp cloth, but do not allow any liquid to enter the set. Do not clean with liquids or aerosols.

Exposure to Heat: Do not touch the heatsinks while the set is working.

• Table of Contents

Contents	Page No.
• Features / General Description of Product	4
• Part Name & Function of Each Unit	
• Central Amplifier CMA-5400	5
• Chairman Unit CMC-5100	7
• Delegate Unit CMD-5200	7
• MP3 Record / Playback Facility : Controls & Features.	8
• MP3 Record / Playback Facility : Operating Procedure	9
• Interconnections	10
• Typical Applications	11
• Usage of Junction Box	12
• Description of Special Functions / Features	13
• System Expansion with DC Injection Box	14
• Dimensional Diagrams.	15
• Specifications	16

• Features / General Description of Product

- The Ahuja Conference System CM-5000 facilitates smooth conduct of meetings by providing clear and intelligible sound reinforcement. The system is designed to handle a wide variety of conference applications in Boardrooms, Convention Halls, Hotels etc.
- Very high quality 18.5" (47cm) long gooseneck condenser microphone which can be shared by two delegates, if required.
- Bright LED indicator on the mic for visual indication of MIC ON status.
- Chairman/Delegate Units have attractive and well contoured plastic top for superior appearance.
- Rugged and compact die cast aluminium base for better stability of Chairman/Delegate Units.
- Adjustable headphone output available from each Chairman/Delegate Unit.
- Automatic Mic Off feature in Delegate units. The mic switches off automatically after some time if the delegate forgets to switch it off. This feature can be disabled through a switch in the Central Amplifier, if not required.
- Chairman Unit has Priority Switch. When PRIORITY is pressed, only the Chairman mic will work. All delegate microphones will get muted.
- Central Amplifier has a high quality digital mp3 recorder for recording the proceedings. Also this feature can be used to playback pre-recorded messages and speeches.
- Send/Return facility provided in the Central Amplifier. This can be used for connecting external equipment like graphic equalizer, feedback destroyer, etc. The Send / Return jack can be bypassed with a switch, if so required.
- Three Mic inputs and one Aux input in the Central Amplifier.
- Central Amplifier CMA-5400 has a 50 watt amplifier which can be used for connecting additional speakers.
- Headphone output provided in Central Amplifier for monitoring purposes.
- Conference System can be installed in a bus bar arrangement by using Junction Boxes CB-45.
- Central Amplifier has the facility of feeding two independent groups of Delegate Units as required in large conference setups.
- AC Mains & 24V DC operation.
- Central Amplifier is 19" rack mountable.

• Part Name & Function of Each Unit

Central Amplifier CMA-5400

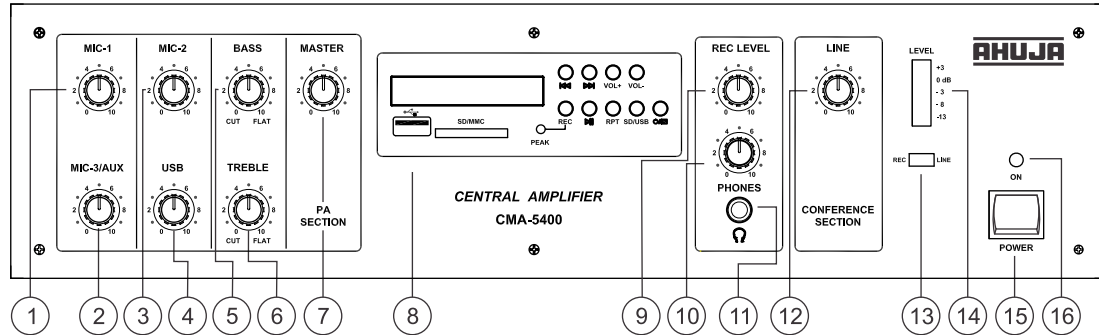

1. **MIC-1 Volume Control**
2. **MIC-3/AUX Volume Control**
3. **MIC-2 Volume Control**
4. **USB Volume Control**
For controlling the level of playback from a USB pendrive or SD card.
5. **BASS Control**
For attenuating the signal level of low frequencies.
6. **TREBLE Control**
For attenuating the signal level of high frequencies.
7. **MASTER Volume Control**
For adjusting the overall volume level from the built-in amplifier.
8. **MP3 Digital Recorder**
9. **REC LEVEL Volume Control**
For adjusting the recording level of the digital recorder. This will not affect the listening level in the conference units or external speakers (if connected).
10. **HEADPHONE Volume Control**
For adjusting the listening level in headphones connected to the Central Amplifier. This will not affect the listening level in the conference units or external speakers (if connected).
11. **HEADPHONE Stereo Jack Socket**
For connecting headphones.
12. **LINE Volume Control**
For adjusting the volume level from the conference units.
13. **REC/LINE Selector Switch**
For routing either record level signal or LINE level signal to the level indicator LEDs. When recording, this switch can be kept in the REC position to show the recording level. When no recording is being done, this switch can be kept in the LINE position to show the level in the conference units.
14. **LED LEVEL INDICATOR**
When switch (13) is in REC position, the LEDs show the recording level. When switch (13) is in LINE position, the LEDs show the sound level in the conference units. Ensure that the red LEDs are not continuously ON.
15. **POWER Switch**
Push the top part of the knob to switch the central amplifier ON. Push the bottom part of the knob to switch the central amplifier OFF.
16. **POWER LED**
This LED glows when the amplifier is switched ON.

• Part Name & Function of Each Unit

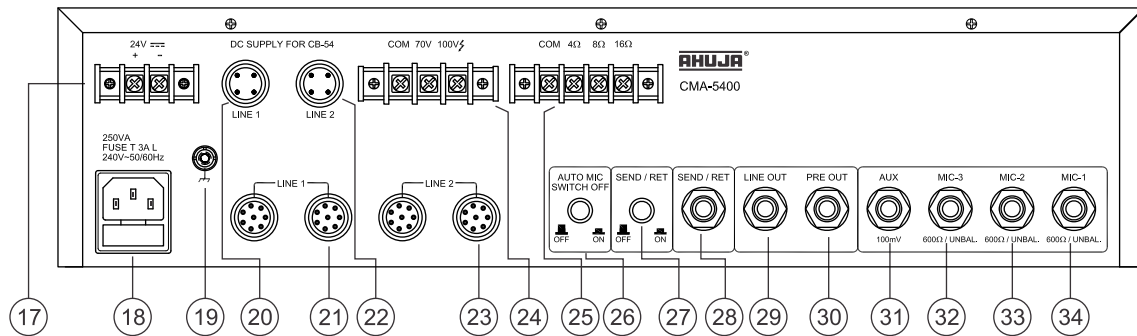

17. Battery Terminal Strip

For connecting two 12V Car Batteries in series (which becomes 24V) as standby power source.

18. IEC Mains Socket with 3 Amp Fuse

Connect the AC mains lead supplied to this socket.

19. EARTH Terminal

For grounding the equipment.

20. 4-Pin Connector for LINE 1

For connecting the DC injection box CB-54 in LINE 1.

21. 8-Pin Connectors for LINE 1

For connecting the conference units of LINE 1 in a closed loop.

22. 4-Pin Connector for LINE 2

For connecting the DC injection box CB-54 in LINE 2.

23. 8-Pin Connectors for LINE 2

For connecting the conference units of LINE 2 in a closed loop.

24. SPEAKER Terminal Block (70V, 100V)

For connecting speakers with 100V line matching transformers.

25. SPEAKER Terminal Block (4Ω, 8Ω and 16Ω)

For connecting low impedance speakers.

26. Auto Mic Switch Off Selector Switch

For selecting the facility of automatic 'Switch Off' for Delegate microphones. When this switch is pressed (ON), any delegate mic which is unused for about 75 sec. will switch OFF automatically. If this switch is unpressed (OFF), this feature is disabled.

27. SEND / RETURN ON/OFF Switch

For selecting the SEND/RETURN facility. If any external graphic equaliser or feedback destroyer is used through the SEND/RET Jack, keep this switch unpressed in OFF position. Otherwise, keep this switch pressed in ON position.

28. SEND / RETURN Stereo Jack Socket

For connecting an external signal processor like a feedback destroyer, compressor limiter etc.

29. LINE Output Jack Socket

For connecting to a booster amplifier to obtain combined higher power output.

30. PRE-AMP Output Jack Socket

For connecting to the AUX input of another amplifier or an external recorder for recording purpose.

31. AUX Input Jack Socket

For accepting an unbalanced signal from an auxiliary source like a Tuner, Cassette Player, Echo or Audio Mixer etc.

32. MIC-3 Input Jack Socket

For accepting unbalanced signal from a low impedance microphone.

33. MIC-2 Input Jack Socket

34. MIC-1 Input Jack Socket

• Part Name & Function of Each Unit....

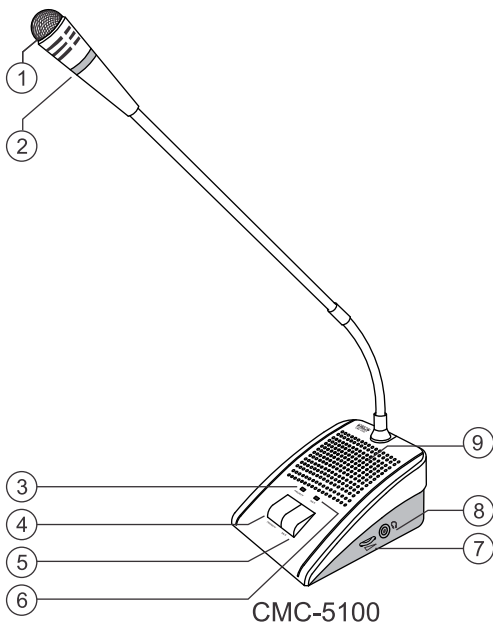

CMC-5100

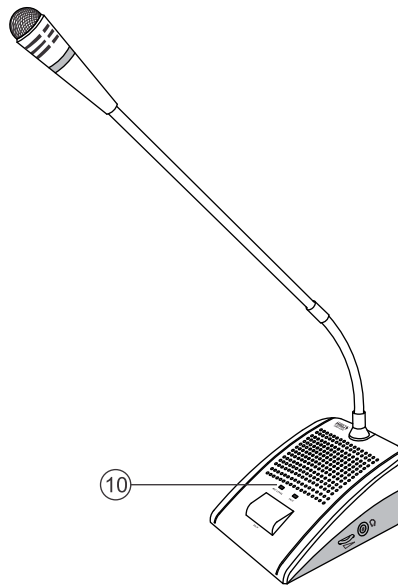

CMD-5200

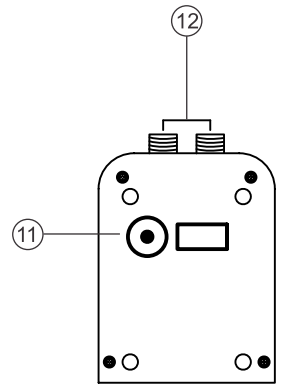

Bottom View

CHAIRMAN UNIT CMC-5100

1. MICROPHONE

2. RING LED:

This lights up when the microphone is switched ON by pressing TALK or PRIORITY switch.

3. PRIORITY LED:

This LED glows when the microphone is switched ON by pressing PRIORITY Switch. Under this condition, all delegate microphones will be switched OFF, and only the Chairman's mic will remain ON.

4. PRIORITY Switch:

On pressing this switch, the chairman can interrupt the conference and assume priority over the other delegates. A chime tone is audible through the speakers of all the Delegate Units and the microphones of the delegate units get muted. Only the Chairman's mic remains ON. Priority switch is non lockable and has to be kept in pressed position for the duration of the priority.

5. TALK Switch:

On pressing this switch once, the delegate microphone is switched ON alongwith the talk LED and the ring LED while the built-in speaker of that particular delegate unit gets muted.

On re-pressing TALK switch, the microphone is switched OFF and the built-in speaker gets active.

6. TALK LED:

This LED glows when the microphone is switched ON by pressing Talk switch.

7. HEADPHONE VOLUME Control:

For adjusting the output level from the headphone jack socket in the delegate unit.

8. HEADPHONE Jack Socket:

For connecting a 3.5 mm stereo headphone plug.

9. SPEAKER

DELEGATE UNIT CMD-5200

This unit is same as the Chairman Unit CMC-5100 except that the Priority Switch is not provided. Function of the parts of the Delegate Unit is similar to the description as for the Chairman Unit.

The highly sensitive electret condenser microphone and flexible, high quality gooseneck permit sharing of a Delegate Unit by two participants.

10. LEVEL LED:

This indicates that the speech level through the microphone is adequate. Delegates, when speaking, should check that this LED glows. (If the MIC is ON, but the LEVEL LED is not glowing, it could be that the sound level reaching the microphone is not adequate).

BOTTOM VIEW

11. SPEAKER VOLUME Control:

For adjusting the output level from the built-in speaker.

12. 8-Pin LINE Connector:

For interconnecting the units through a 2.5m long 8-core shielded cable.

• MP3 Record / Playback Facility: Controls & Features

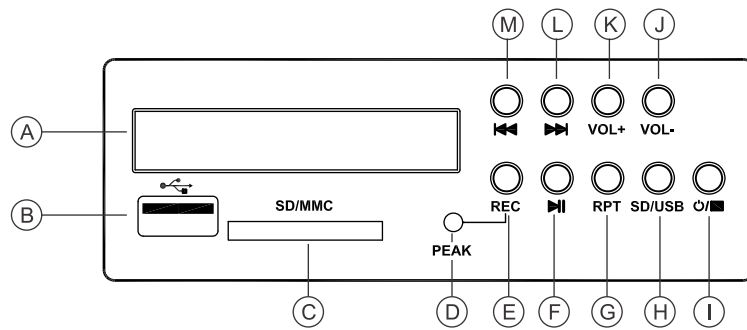

- A. LCD Display:** Displays 3 digits of the track being played i.e 001 to 999. If number exceeds 999, it will reset to 001.
- B. USB Connector:** Insert the USB drive here. While inserting USB drive into the USB connector, hold the USB drive in such a way that hollow part of the USB drive is upwards. Do not apply pressure in an attempt to forcibly insert a USB drive which is not in correct orientation.
- C. SD/MMC Card Connector:** Insert the SD/MMC Card into its appropriate slot. When taking out the card, pull the card to take out. While inserting SD/MMC card into the slot, ensure that the card is inserted in such a way that all pins are facing downward and cut is towards right.
- D. PEAK:** The continuous glowing of this red LED indicates that the recording level is high & should be reduced through REC control.
- E. REC:** Press REC button twice to start recording function. Press once to stop the recording.
- F. Play/Pause:** Press PLAY/ PAUSE once to pause if music is already playing. Press PLAY / PAUSE again to play.
- G. RPT:** This repeat RPT button has three options:
- Press RPT button once to display RPT which means the system will play tracks at random.
 - Press once again to display RPT which indicates that all the tracks get repeated.
 - Press once again to display RPT which indicates that the current track will keep repeating. Press again to cancel repeat function.
- If display does not show RPT, repeat function is not active.
- H. SD/USB:** Press SD/USB once to select between SD/MMC card and USB only when both are inserted.
- I. :** If MP3 recorder is OFF, keep pressed for 3 sec. to switch it ON. Press this button again for 3 sec. to switch OFF the MP3 recorder. During recording function, press this switch once to STOP () recording.
- J. VOL-:** Press VOL- once to decrease the playback output level step by step up to 00 point. For decreasing the output level quickly to the desired level, keep VOL- pressed till it reaches the desired position & then release the button.
- K. VOL+:** Press VOL+ once to increase the playback output level step by step up to 15 point. For increasing the output level quickly to the desired level, keep VOL+ pressed till it reaches the desired position & then release the button.
- L. Next:** Press NEXT to select next forward music track. Pressing NEXT repeatedly will move the system to successively next forward tracks. Long Press NEXT to move to the next folder.
- M. Prev:** Press PREV to select the previous track. Pressing PREV repeatedly will move the system to successively previous tracks. Long press PREV to move to the previous folder.

MP3 Record/Playback Facility: Operating Procedure

System as a Player:-

- a) Press the  button till the display lights up and shows the words of No USB.



- b) Insert the pen drive or SD card into respective port. For a moment the display shows "----", the USB/SD card starts playing and then the display finally appears like below.



- c) Use the volume button on the module to adjust the desired USB playback level.
- d) Press  button to stop the track being played. The display appears like below.



- e) Setting of volume level remains in memory, once it is set.
- f) Bass and Treble setting can be done for desired tonal quality.

System as Recorder:-

- a) Insert the pen drive or SD card into the respective port.
- b) Press REC button once. The module will become ready to record. Display will show REC (blinking) and track no. of recording.



- c) Select Mic or Aux input signal to record. Press REC button second time, the system will start recording and display will show the track no., time elapsed & REC status.



- d) Keep REC/LINE (see item 13 on page 5) switch in 'REC' position and increase the recording level control such that 0dB LED on the LED array just glows occasionally.

- e) Press  button to stop recording. The display will appear like below:-



- f) If you want to record again then proceed same as above. The module will generate next file for recording.
- g) To play the recorded program, press PLAY. The module will start playing the last file recorded.
- (6) To search for folder, press NEXT or PREV for longer period, it will display the folder. Select the desired folder and press PLAY, the module start playing from the track one of that folder.

Interconnections

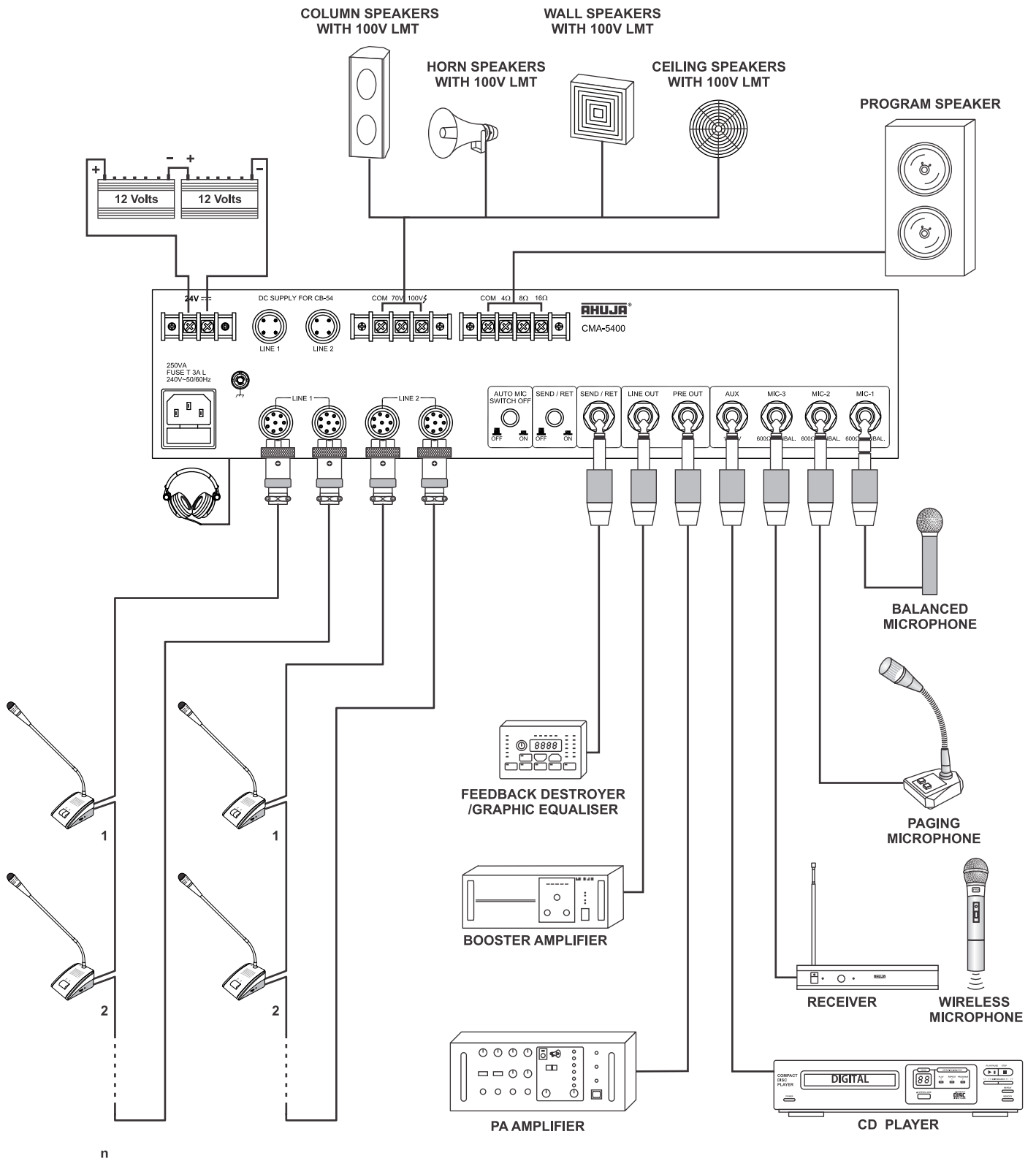

• Typical Applications

Basic Discussion Set-up

This shows an example of a typical small and medium sized venue such as Conference Room, Board Room, Meeting Room etc.

Board Room

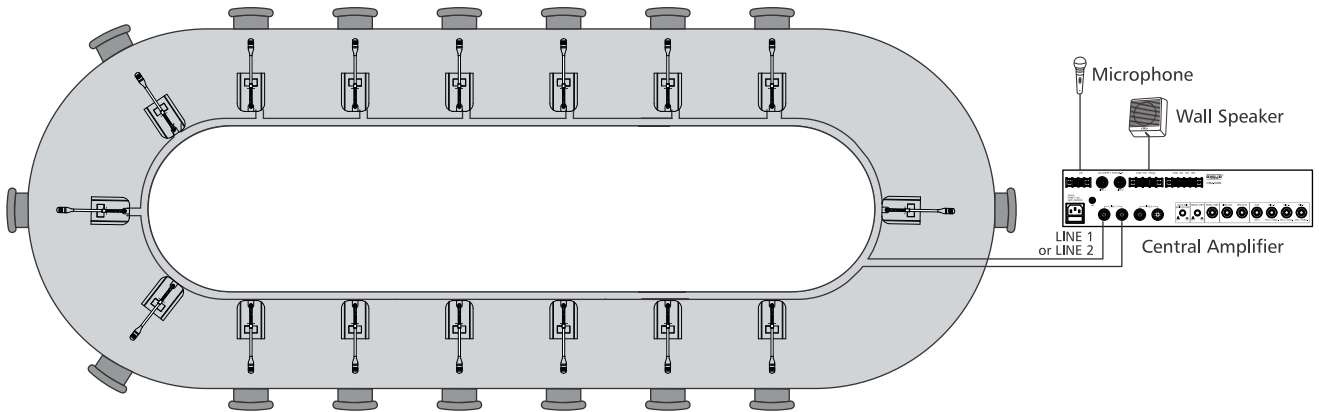

Convention Centres

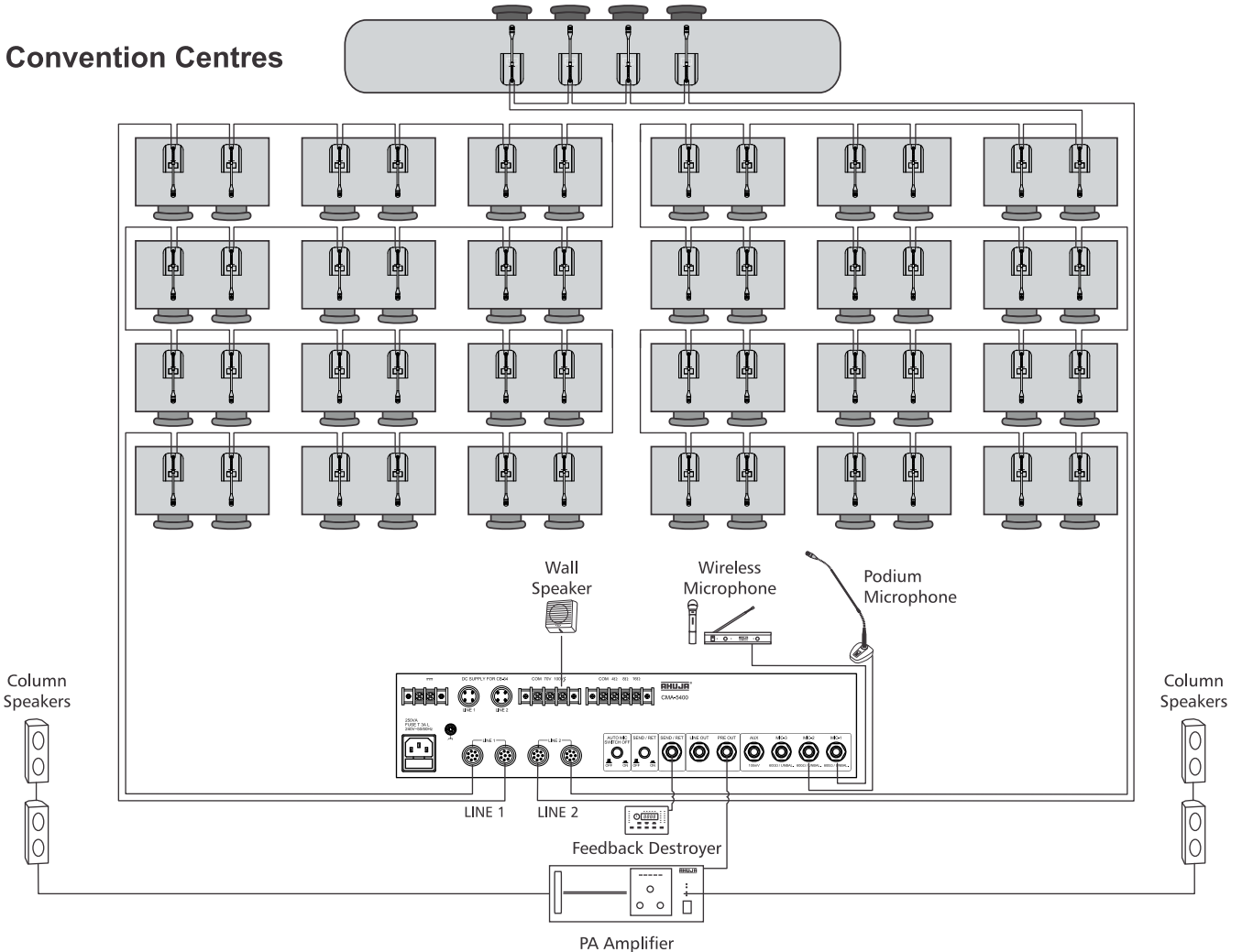

• Usage of Junction Box

- Some installations may require single cable connection from the conference unit to the main cable line (bus bar). This is possible by using Junction Box CB-45 for each unit. The interconnections can be done as shown below. Each Junction Box is supplied with a 2.5m cable which is terminated with 8-pin female plugs on both ends.

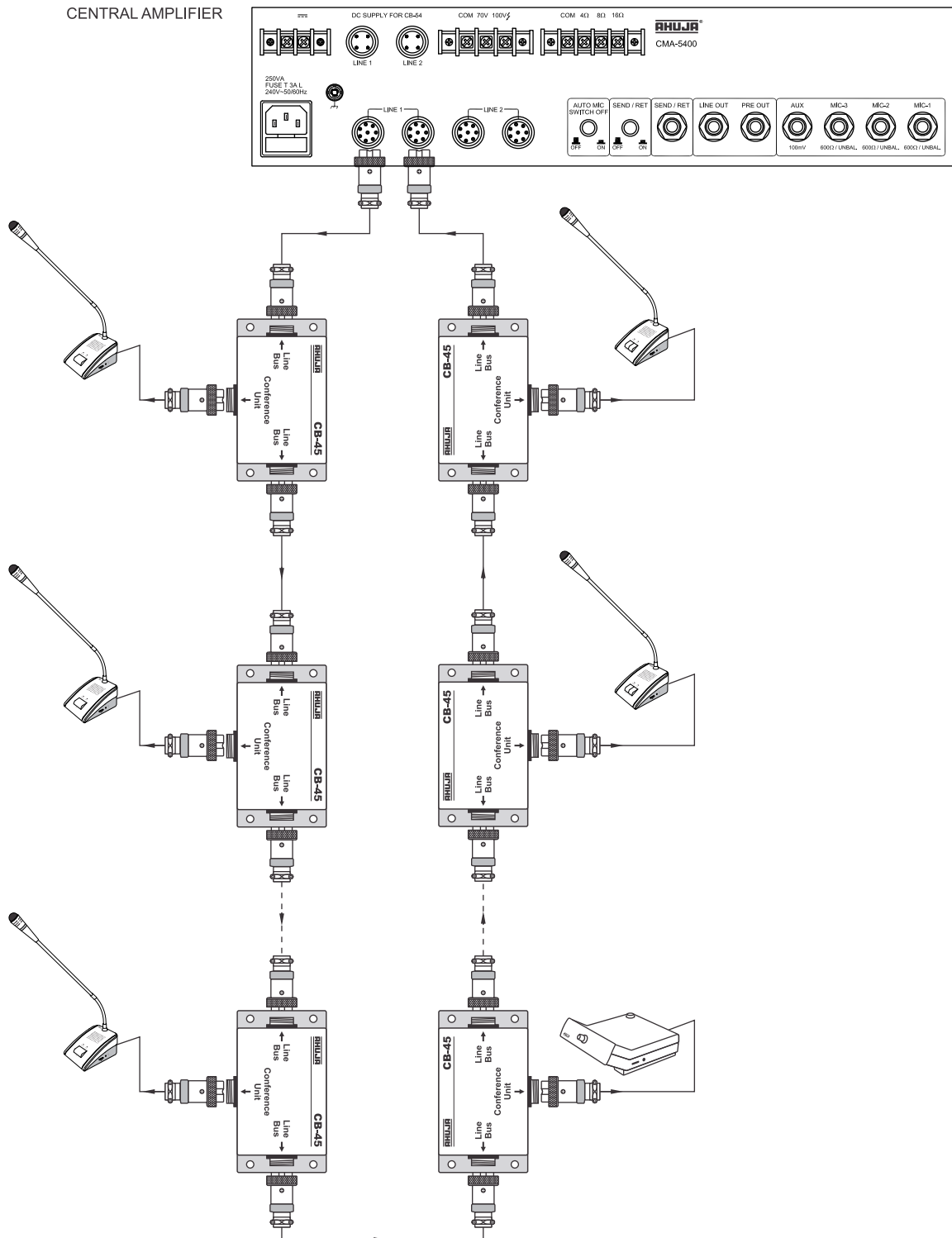

• Description of Special Functions / Features

■ Automatic Mic Off Function

The microphone is automatically switched off after approximately 75 seconds if a delegate is no longer speaking into the mic but forgets to switch the mic OFF.

When long pause in the speech is expected before hand or the ambient noise level is high, it is suggested to disable this function by placing 'AUTO MIC SWITCH OFF' switch of Central Amplifier in OFF position.

■ Priority Function

A priority switch on the Chairman's Unit has been provided for seeking attention of all the delegates during a conference. When priority switch is kept pressed, a chime tone is heard and all the active delegate microphones get muted. Only the Chairman's mic remains ON. Priority function gets withdrawn when the priority switch is released by the Chairman.

■ Send / Return Jack

This feature has been provided in the Central Amplifier for connecting an external signal processor like a feedback destroyer or a graphic equalizer. These external signal processors are ideal for those conference rooms / halls which are prone to

feedback and howling problems. The external processor can be connected to Send / Return jack socket of the Central Amplifier through a 1/4" stereo jack plug. If the SEND / RETURN feature is not being used, it is advisable to keep the SEND / RETURN switch on the rear panel of the central amplifier in OFF position.

■ Headphone Function

Each conference unit provides a 3.5mm stereo headphone socket along with a rotary volume control for adjusting the level of headphone output. The volume level of headphone is not affected by the setting of speaker volume control of the unit.

The central amplifier has a 6.3mm headphone socket and a separate headphone volume control on the front panel.

■ Built-in PA Amplifier

In certain situations, additional sound reinforcement through external speakers may be required. Hence, the Central Amplifier has a built-in 50W PA amplifier for powering these external speakers.

■ Built-in Digital Recorder/Player

This is specially useful for recording the conference proceedings, or for playing back recorded speeches / messages.

Cables & Connectors

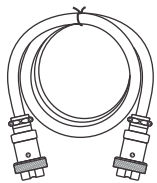

Connection Cable **CC-46**

10m connection cable terminated with 8-pin female plugs on both ends.

8-pin Female Plug

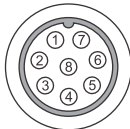

8-pin Male Socket

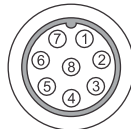

(As viewed from soldering side)

Pin 1 : +ve Supply	Pin 2 : Ground
Pin 3 : Mic Auto Off	Pin 4 : Signal Out
Pin 5 : Signal Out	Pin 6 : Signal In
Pin 7 : Signal In	Pin 8 : Priority

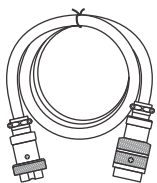

Extension Cable **CC-47**

10m extension cable terminated with 8-pin female plug at one end and 8-pin male plug at the other end.

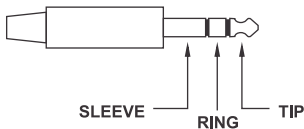

6.3mm (1/4")
Stereo Phone Plug for
Send/Return Application

Tip	: Send
Ring	: Return
Sleeve	: Ground

DC Injection Box CB-54

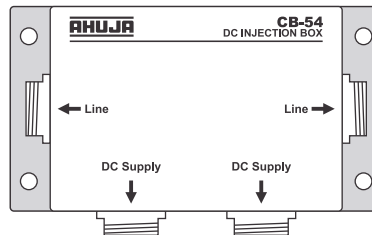

4-Pin Female Plug

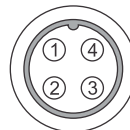

4-Pin Male Socket

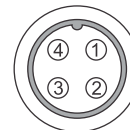

(As viewed from soldering side)

Pin 1 : +ve Supply	Pin 2 : +ve Supply
Pin 3 : Ground	Pin 4 : Ground

Connection Cable CC-55

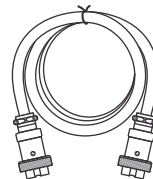

25m connection cable terminated with 4-pin female plugs on both ends.

• System Expansion with DC Injection Box

System Interconnections

The Central Amplifier CMA-5400 is provided with two sets of LINE connectors i.e., LINE1 and LINE2

In case of small sized set-ups of upto 30 conference units, either LINE1 or LINE2 can be used to connect the conference unit in closed loop. See figure on page 11 under “Board Room”.

In case the number of conference units is more than 30, it is advisable to split the total no. of units in two groups and connect each group to LINE1 and LINE2. See figure on page 11 under “Convention Centers”.

System Expansion with DC Injection Box

Some medium and large installation can demand long lengths of interconnecting cables. This causes some fall in the supply voltage and hence low power output. To overcome this situation, procurement and use of DC Injection boxes model CB-54 is recommended.

The Central Amplifier has two 4 pin connectors marked DC supply for CB-54, provided for LINE1 and LINE2.

Each DC Injection Box CB-54 consists of two nos. of 8-pin male connector marked as LINE and two nos. of 4-pin male connector marked as DC SUPPLY.

The first conference unit is connected to the Central Amplifier CMA-5400 through the 8 pin connector of LINE1.

The conference unit near the centre of the wiring loop is interconnected through the LINE connectors of the DC Injection Box CB-54.

The remaining conference units are connected in the usual closed loop formation.

Now connect the 4-pin DC Supply connector of LINE1 to the 4 pin DC supply connector of the DC Injection Box CB-54, through a connection cable of a required length which is available as an optional accessory. See Fig. below.

Additional connection cable for DC Injection are available in three different lengths as listed below:

CC-55 (25m), CC-56 (50m) & CC-57 (100m).

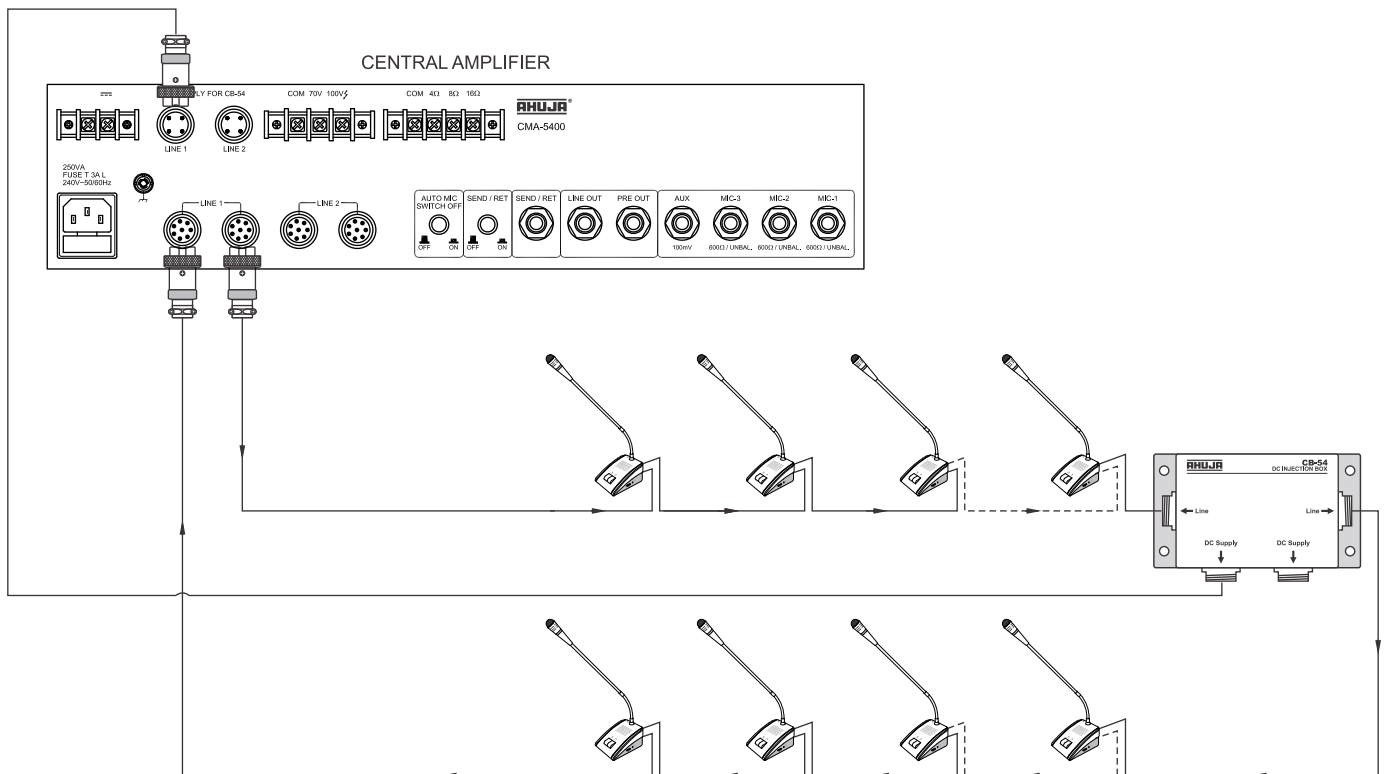

• Dimensional Diagrams

Central Amplifier CMA-5400

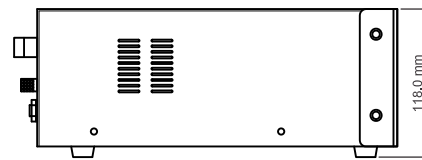
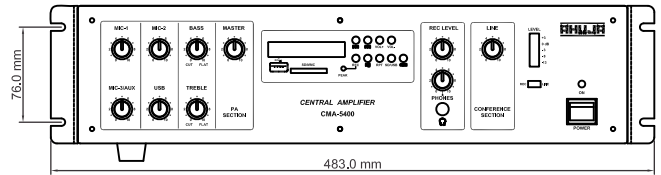
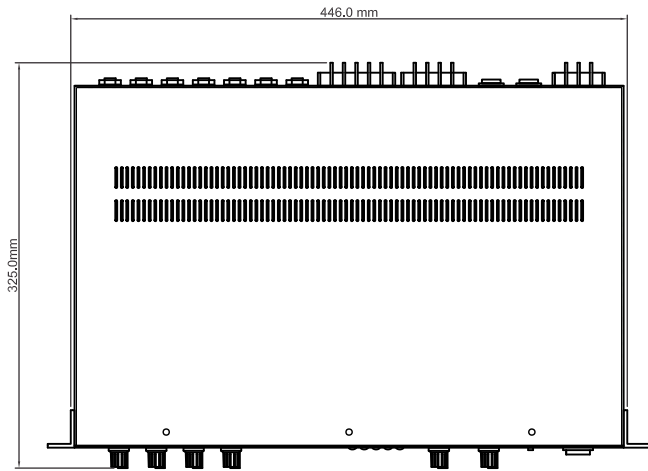

Chairman Unit CMC-5100

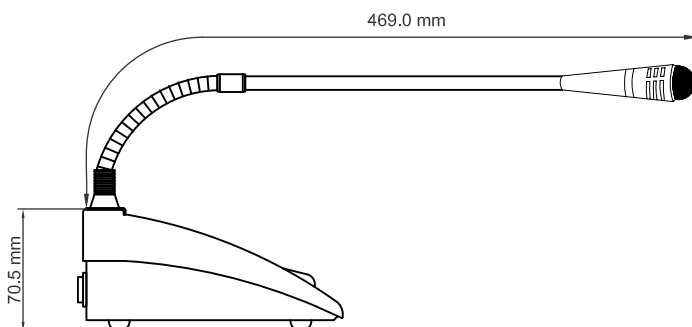
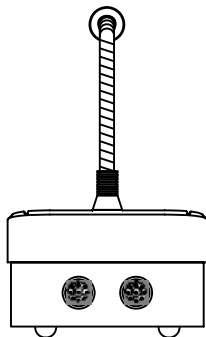
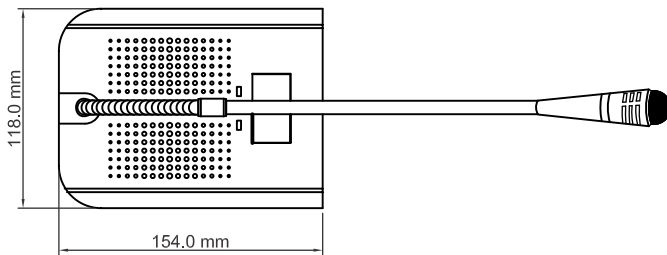

Junction Box CB-45

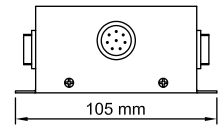
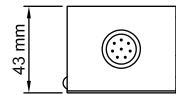
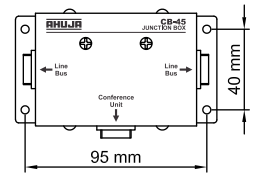

DC Injection Box CB-54

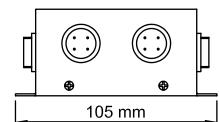
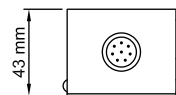
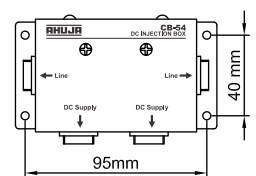

• Specifications

Model	Chairman Unit CMC-5100	Delegate Unit CMD-5200
Microphone	-63dBV/mbar, (7.5mV/Pa)	-63dBV/mbar, (7.5mV/Pa)
Current Consumption	< 50mA Max.	< 50mA Max.
Mic Auto Switch-Off Time	75 seconds approx.	75 seconds approx.
Input	Line	Line
Output	Line, Headphone	Line, Headphone
Speaker	Max Input 300mW	Max Input 300mW
Controls	Priority Switch, Talk Switch, Speaker, Volume Control, Headphone Volume Control	Talk Switch, Speaker Volume Control, Headphone Volume Control
Dimensions	W118 × H70 × D160 mm	W118 × H70 × D160 mm
Weight	1.05 kg (w/o cable)	1.05 kg (w/o cable)
Accessories	Foam Windshield, 2.5m Interconnecting Cable	Foam Windshield, 2.5m Interconnecting Cable

Central Amplifier CMA-5400	
Power Output	50W RMS at 2% THD, 90W Max.
Inputs	3×Mic 0.65mV/4.7kΩ, 1×Aux 100mV/470kΩ
Line Output 1	17.5V DC/3A Max.; -34dBV (20mV)
Line Output 2	17.5V DC/3A Max.; -34dBV (20mV)
Frequency Response	60-14,000Hz (± 3dB)
S/N Ratio	> 60dB
Tone Controls	Bass: -10dB at 100Hz Treble: -10dB at 10kHz
Preamp Output	200mV/600Ω
Line Output	1V/1kΩ (nominal)
Send Output	200mV/600Ω (nominal)
Return Input	200mV/10kΩ (nominal)
Speaker Output	4Ω, 8Ω, 16Ω, 70V & 100V
Power Requirement	AC: 220-240V, 50/60HZ DC: 24V (2×12V Car Battery)
Power Consumption	250VA
Protections	AC Fuse 1×3 Amp, DC Fuse 2×10 Amp
Dimensions	W483 × H110 × D325 mm
Weight	10.50kg
Accessories	1× Connection Cable CC-46, 1× Extension Cable CC-47, 1× Fuse 3 Amp, 2 × Fuse 10 Amp.

AHUJA RADIOS • 215, Okhla Industrial Estate, New Delhi - 110 020, INDIA
 Tel.: +91-11-26831549, 41612474 Fax : +91-11-26847287
 E-mail: ahuja@ahujaradios.com, admin@ahujaradios.com
 Website: www.ahujaradios.com

- Design and Specifications are subject to change without notice owing to continuous product up-gradation
- Technical specifications are subject to production tolerances.
- We cannot be held responsible for printing errors, should they occur.
- AHUJA is a registered trademark of Ahuja Radios in India and other countries.
- © Copyright Ahuja Radios, 2014. All rights reserved. Any unauthorized reproduction or use of logos, images or design elements is strictly prohibited by law.
- No part of this compilation may be reproduced in any manner or translated without written permission.

